

“No matter where I go, You guide me.”

Follow the path to a safe place.
1 2 3 4 5 6 7 8 9 10 11 12 13 14

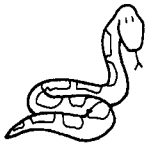

1	8	2	13	5	9
2	10	6	7	8	1
3	4	5	12	9	3
8	6	9	3	10	6
4	10	5	6	11	12
12	7	6	4	7	13
2	3	4	8	6	14

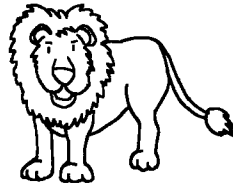
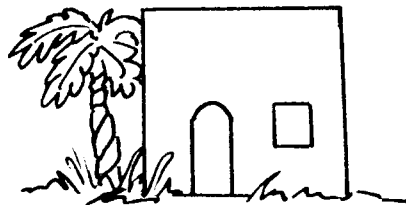

Ages 3+

November 27, 2022 • Psalm 139:1-12, 23-24

God's Complete Knowledge and Care

“O Lord, You know me.”

Add these things to the picture.

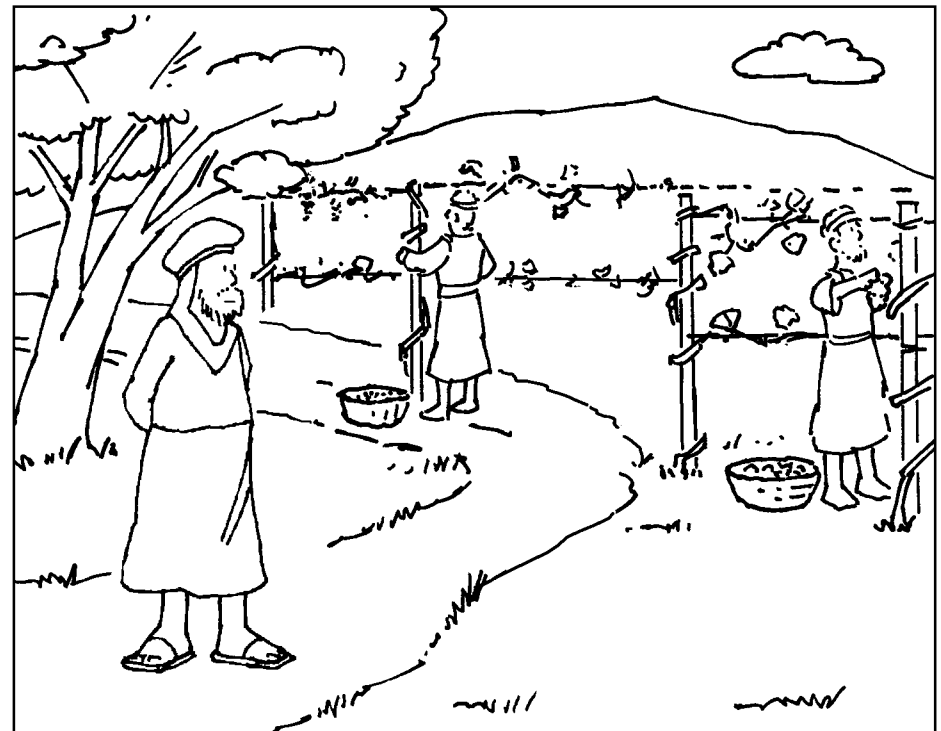

Christ Covenant PCA
12915 Kingston Pike
Knoxville, TN 37934
(865) 671-1885

“You know whatever I do.”

“Your knowledge is too wonderful for me.”

Circle the one that doesn't match in each row.

Trace the words.

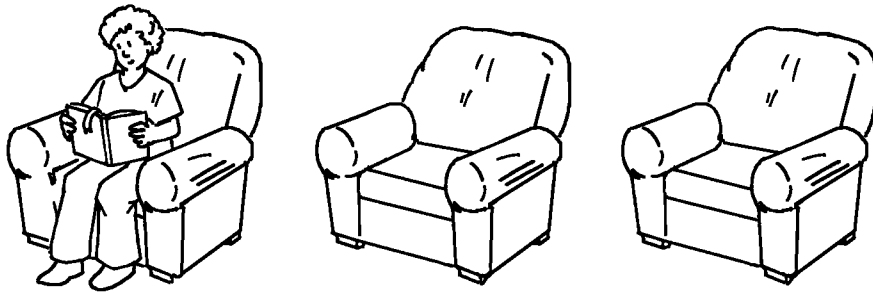
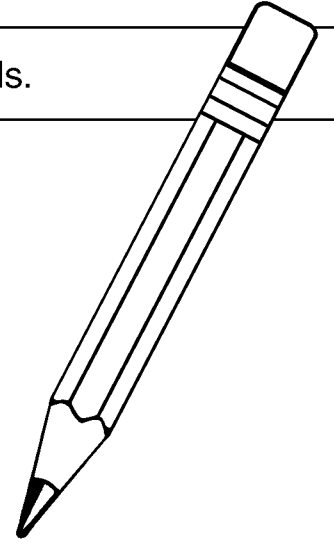
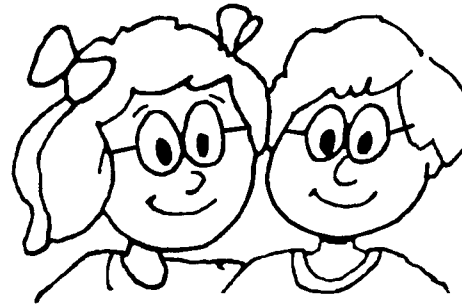

God

is

great!

