

# advent CALENDAR

Perform a random act of kindness

1

two

Donate food to a local food bank

Have a coloring contest

3

four

Buy socks for a homeless shelter



5

Watch a favorite holiday movie

Make or buy a new Christmas ornament

6

Let someone go in front of you in line

seven

8

Clean out and donate outgrown toys

Build a snowman out of cotton balls

9



Take cupcakes to your local fire department

10



Decorate a gingerbread house

eleven

Help wrap a Christmas present



thirteen

Leave a happy note for someone to find



Have a game night in your PJs

14



15

Make paper snowflakes

Drink hot cocoa



17

Make Christmas cards



18

Bake Christmas cookies



19

Sing Christmas carols



twenty

Take a family photo in front of the Christmas tree

Read your favorite Christmas story

21

Take a car tour of your local light displays

22

Deliver Christmas cards to your neighbors



23

Watch or attend a Christmas Eve service

twenty-four



Read the Nativity story

25



# Merry Christmas!

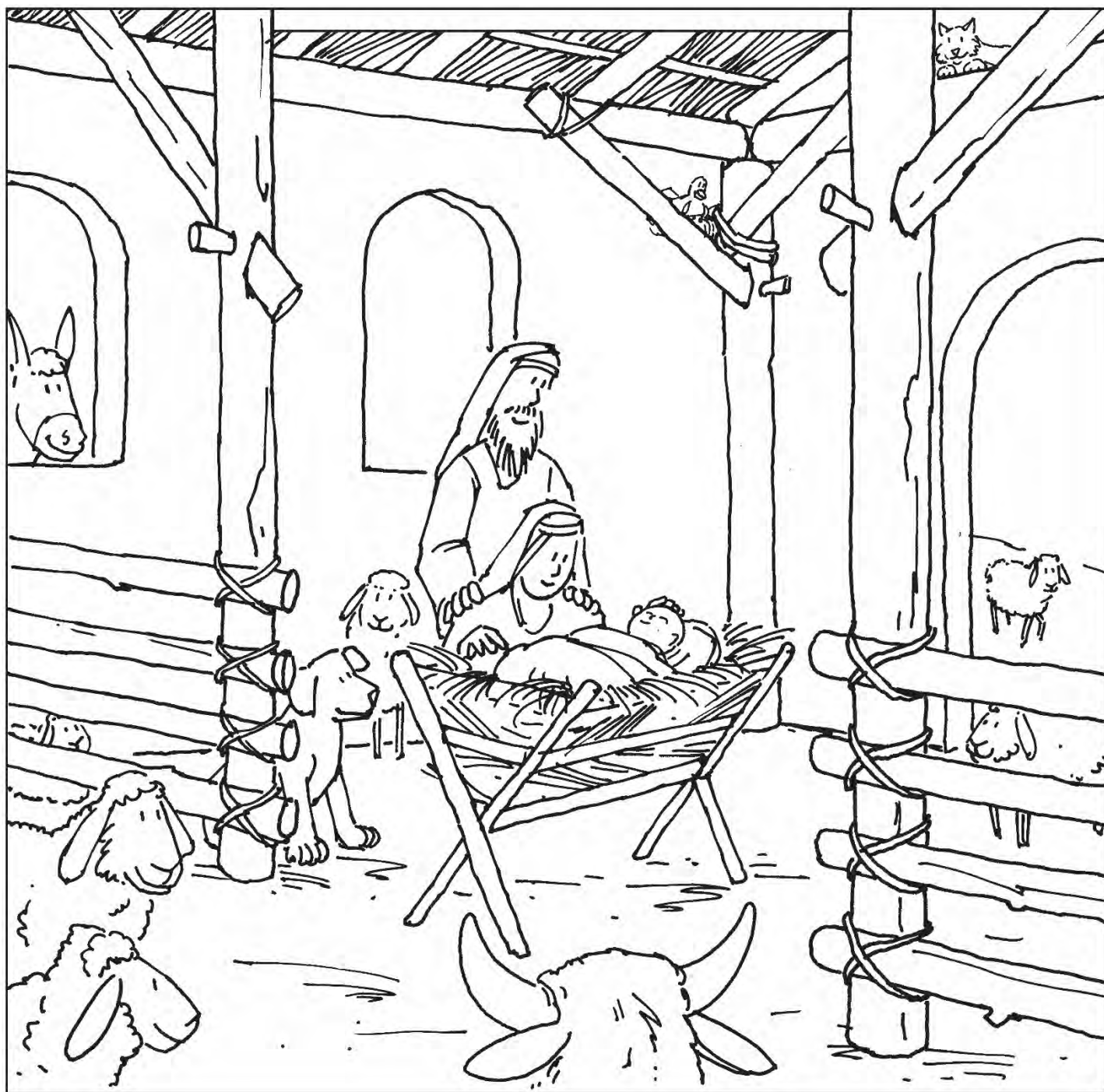



# The Christmas Story

– Activity Pages – Older –



From your friends at *Children's Worship Bulletins*  
[www.ChildrensBulletins.com](http://www.ChildrensBulletins.com)

M

ary and Joseph had to travel from Nazareth to Bethlehem for the census ordered by Caesar Augustus. It was a long journey, and there were many people there. They found shelter in a stable. There Jesus was born. Mary wrapped the baby in cloths and placed him in a manger. There were shepherds watching their sheep in the hills. Suddenly something appeared to them.

Copy the drawing into the correct squares.

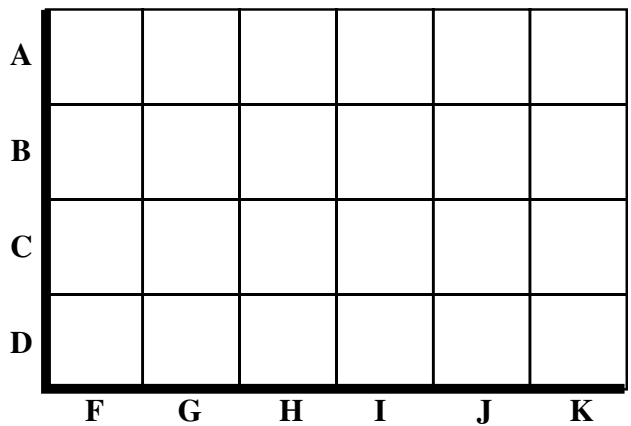
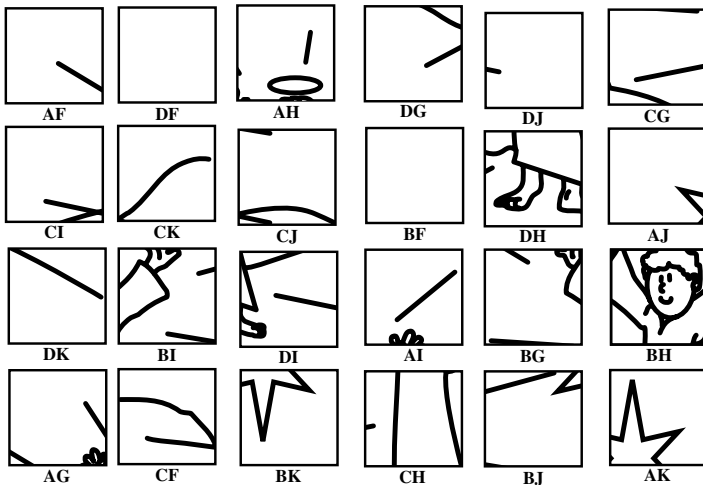

In the Scripture verses, there are words underlined. Find them in the puzzle. They are up and down, across or diagonal. There will be 17 letters that remain uncircled. Write them in order on the lines.

“Do not be afraid. I bring you good news of great joy that will be for all the people. Today in the town of David a Savior has been born to you; he is Christ the Lord.”

—Luke 2:10-11

“Glory to God in the highest, and on earth peace to men on whom his favor rests.”

—Luke 2:14

Who said these words to the shepherds?

\_\_\_\_\_

\_\_\_\_\_

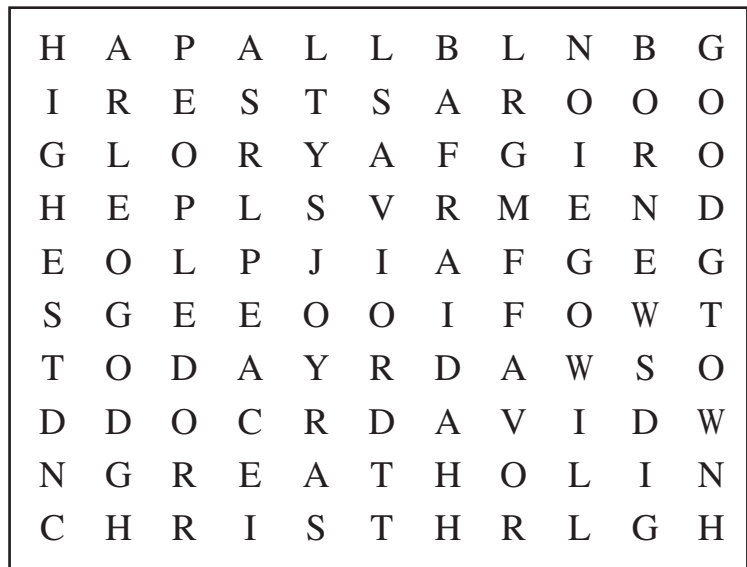

Name \_\_\_\_\_

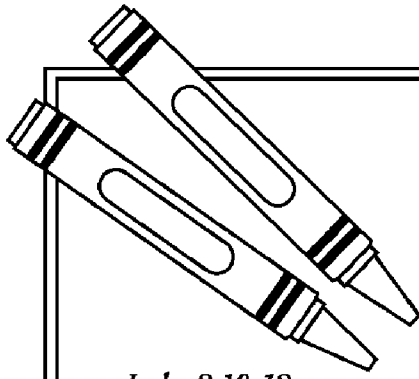

# Just for **KIDS**

## The Angel Appeared

Luke 2:10-12

There were shepherds in the fields watching their flocks. Suddenly an angel of the Lord appeared to them. Find the words that the angel spoke. First fit the words from the list into the squares. Next, write the words on the correct lines.



- |      |         |
|------|---------|
| Do   | This    |
| be   | sign    |
| has  | find    |
| all  | baby    |
| for  | lying   |
| not  | bring   |
| you  | great   |
| joy  | Today   |
| town | David   |
| that | afraid  |
| good | people  |
| news | Savior  |
| will | Christ  |
| been | cloths  |
| born | manger  |
| Lord | wrapped |

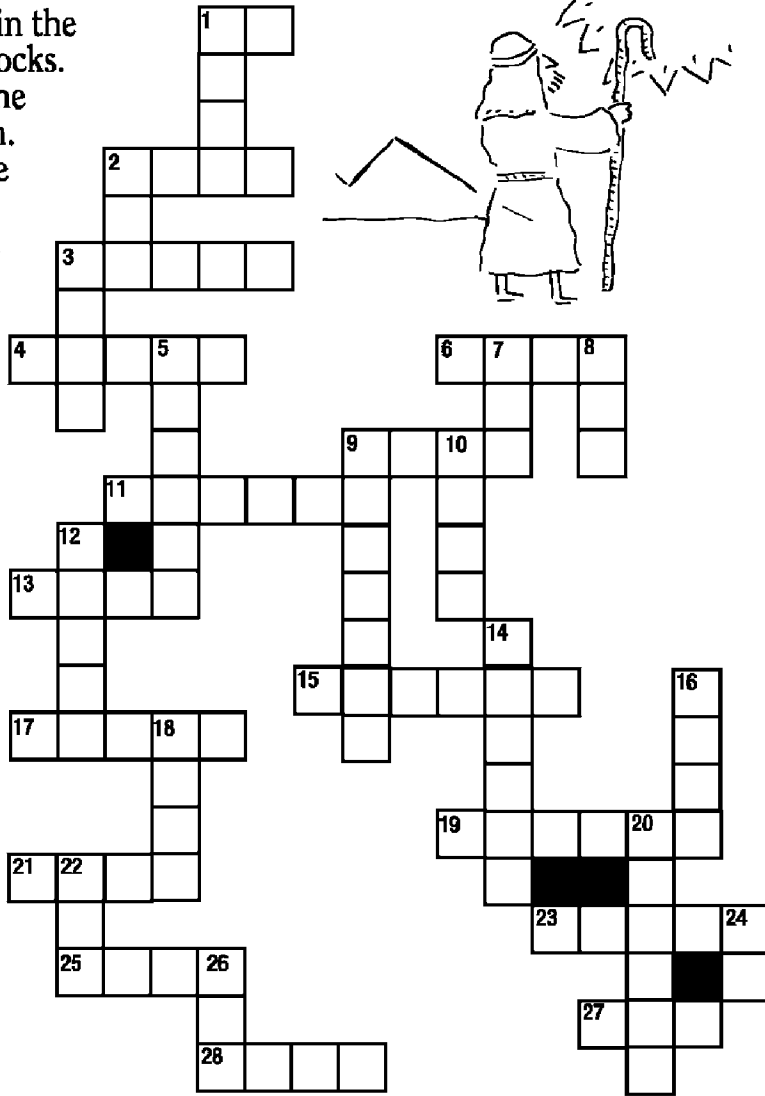

“ \_\_\_\_\_ . I \_\_\_\_\_ of  
 24 26 1A 5 3A 8 13 18  
 \_\_\_\_\_ the \_\_\_\_\_  
 4 27 16 9A 1A 2D 7 15 12  
 in the \_\_\_\_\_ of \_\_\_\_\_ a \_\_\_\_\_  
 28 23 20 22 1D 3D  
 to \_\_\_\_\_ ; he is \_\_\_\_\_ the \_\_\_\_\_ .”  
 8 19 10

**K**ing Herod was upset at the thought of the “king of the Jews.” He planned to find the child and kill Him. He sent the Magi to find the child and report back to him.

Follow the spiral path of letters. Every other letter will reveal what happened. Write the letters on the lines.

“W \_\_\_\_\_

\_\_\_\_\_

\_\_\_\_\_

\_\_\_\_\_ ? \_\_\_\_\_

\_\_\_\_\_

\_\_\_\_\_

\_\_\_\_\_

\_\_\_\_\_ .”



Add and subtract words and letters to fill in the blanks.

- hir + - c =
- agn + - oe + - car + - n + - og =
- pi + - w + - ove =
- ie + - hd + - g + - t + - ar =
- 1 + - sta + - chuc =
- c + - lov + =
- g + - ke + - eanus =

The 1) \_\_\_\_\_ led the Magi to the house where Joseph, Mary and Jesus were. They went inside and 2) \_\_\_\_\_ Him. They presented gifts of 3) \_\_\_\_\_, 4) \_\_\_\_\_ and 5) \_\_\_\_\_. God warned them in a dream not to return to Herod. So they went home another way. An 6) \_\_\_\_\_ appeared to Joseph in a dream and told him to take Mary and Jesus and escape to 7) \_\_\_\_\_.

Name \_\_\_\_\_



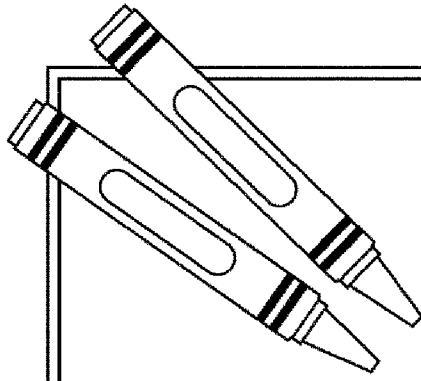

# Just for **KIDS**

## Christmas Riddles

Read the riddles below. Do you know the answers?

1. In a stable I was filled with hay  
And became a bed where a baby lay.

What am I? \_\_\_\_\_ (Luke 2:7)

2. Our voices loud were heard on high!  
The shepherds were frightened when we filled the sky!

Who are we? \_\_\_\_\_ (Luke 2:9-13)

3. I was shining in the Bethlehem sky that night.  
The three kings followed my light so bright!

What am I? \_\_\_\_\_ (Matthew 2:2)

4. We watched our sheep in the night so still;  
Then angels sang and woke up our hill!

Who are we? \_\_\_\_\_ (Luke 2:8)

5. I was at Mary's side for that special birth  
And raised the child as his "father on Earth."

Who am I? \_\_\_\_\_ (Luke 2:16)

6. "My heart in song to God I lift"  
said the young mother of God's special gift.

Who am I? \_\_\_\_\_ (Luke 2:19)

7. A baby boy, the Promised One!  
A gift from God, His beloved Son!

Who am I? \_\_\_\_\_ (Matthew 1:18)

8. The city of David, the little town,  
Where the Baby was born and the star shone down.

What am I? \_\_\_\_\_ (Luke 2:4)

9. From the East we traveled far.  
We found the child by the light of the star.

Who are we? \_\_\_\_\_ (Matthew 2:1)

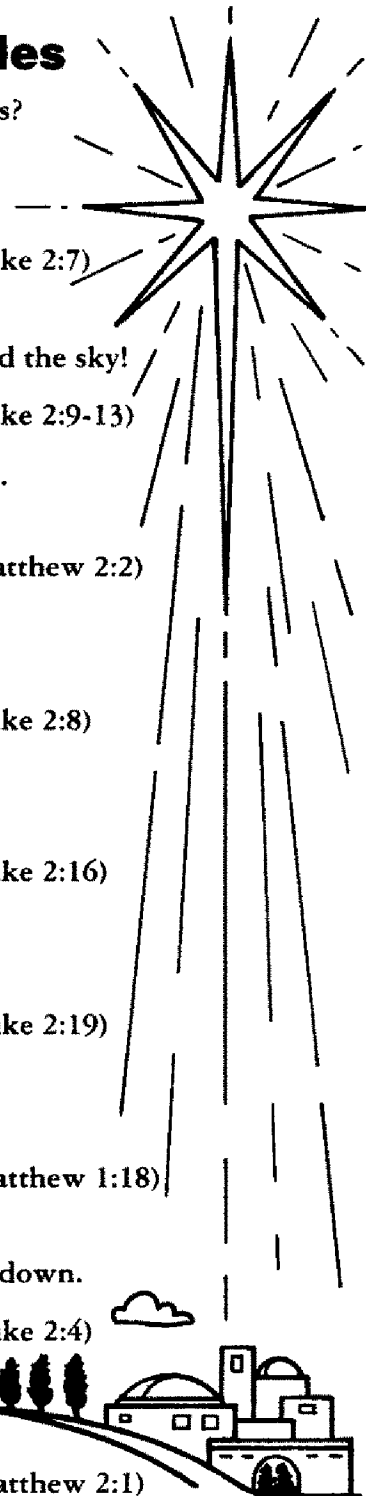

**O**n the 40th day after Jesus was born, Mary and Joseph were required by the Law of Moses to go somewhere and do something.

Find where Mary and Joseph went. Answer each math problem. The spaces that have even-numbered answers make a path through the puzzle. Read the words on those spaces in order.



Start

|                   |                      |                       |                     |                 |                     |                   |
|-------------------|----------------------|-----------------------|---------------------|-----------------|---------------------|-------------------|
| They<br>2x2=___   | water<br>3x3=___     | key<br>6+7=___        | river<br>12-7=___   | to<br>10-2=___  | present<br>8÷2=___  | Jesus<br>2x3=___  |
| went<br>4+2=___   | Gift<br>2+3=___      | an<br>12÷6=___        | offering<br>8+8=___ | and<br>10+4=___ | traveled<br>7x7=___ | to<br>6-2=___     |
| to<br>6-4=___     | out<br>14-7=___      | make<br>5x2=___       | Nazareth<br>5x1=___ | boat<br>4+3=___ | boy<br>9÷3=___      | the<br>8+2=___    |
| the<br>10÷5=___   | mountains<br>9+2=___ | to<br>5+5=___         | fish<br>10÷2=___    | at<br>12-5=___  | lake<br>5x7=___     | Lord.<br>15-5=___ |
| Temple<br>2+2=___ | in<br>5+3=___        | Jerusalem<br>12-4=___ | to<br>1x5=___       | run<br>7x3=___  | a<br>18-9=___       | race<br>3+2=___   |

Two special people recognized Jesus even though He was just a baby. Who were they?

|   |   |   |   |   |   |   |   |   |    |    |    |    |    |    |    |    |    |    |    |    |    |    |    |    |    |
|---|---|---|---|---|---|---|---|---|----|----|----|----|----|----|----|----|----|----|----|----|----|----|----|----|----|
| 1 | 2 | 3 | 4 | 5 | 6 | 7 | 8 | 9 | 10 | 11 | 12 | 13 | 14 | 15 | 16 | 17 | 18 | 19 | 20 | 21 | 22 | 23 | 24 | 25 | 26 |
| C | P | X | G | I | L | M | Z | A | K  | V  | B  | W  | F  | N  | T  | U  | Y  | R  | E  | S  | D  | H  | J  | Q  | O  |

Use the alphabet code to fill in the missing letters.

I was a 14 9 5 16 23 14 17 6 7 9 15. I believed in God's  
2 19 26 7 5 21 20 21. He said that I 13 26 17 6 22 not 22 5 20 until  
I had seen the 7 20 21 21 5 9 23. I was moved by the 23 26 6 18  
21 2 5 19 5 16 to go to the 16 20 7 2 6 20 that day. I lifted the  
12 9 12 18 and 2 19 9 5 21 20 22 God that my 20 18 20 21 had seen  
21 9 6 11 9 16 5 26 15! I am 21 5 7 20 26 15.



I was an elderly 2 19 26 2 23 20 16 20 21 21 who never left the  
16 20 7 2 6 20. I 13 26 19 21 23 5 2 20 22 night and day. I  
10 15 20 13 who this special 1 23 5 6 22 was and 2 19 9 5 21 20 22  
God. I spoke about 23 5 7 to all 13 23 26 waited for the  
7 20 21 21 5 9 23! I am 9 15 15 9.



Name \_\_\_\_\_

Then what did the shepherds do?

Underline all the words containing an "e".  
Then find those words in the word search below.

When they had seen Him, they spread the word concerning what had been told them about this child, and all who heard it were amazed at what the shepherds said to them.

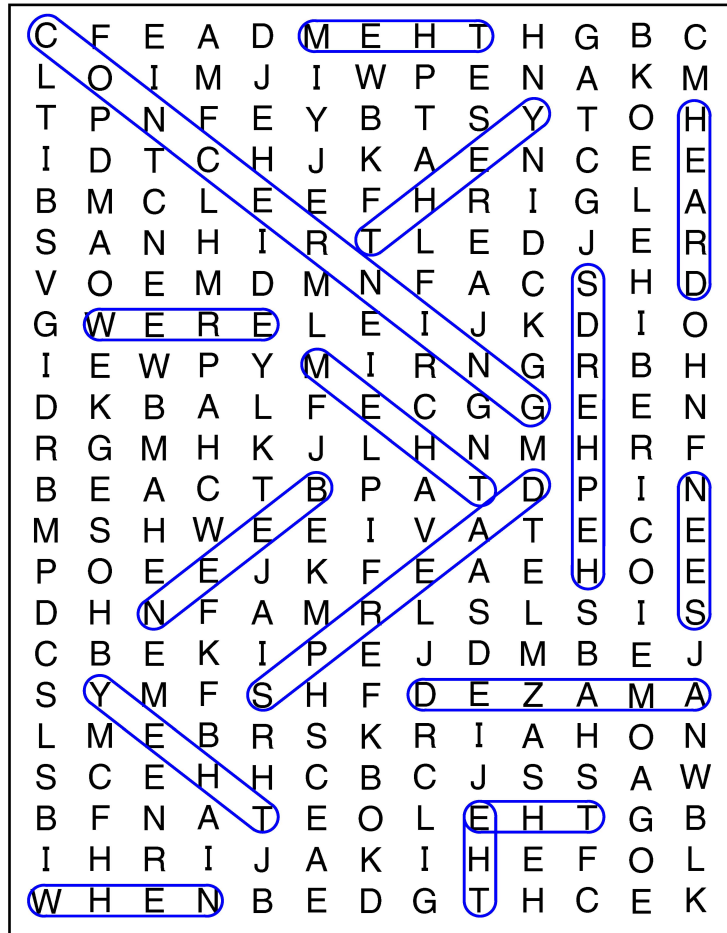

# Merry Christmas!

Ages 7-12

Luke 2:15-21

*We Celebrate the Birth of Our Savior*

I hope you enjoy these Nativity activity pages.

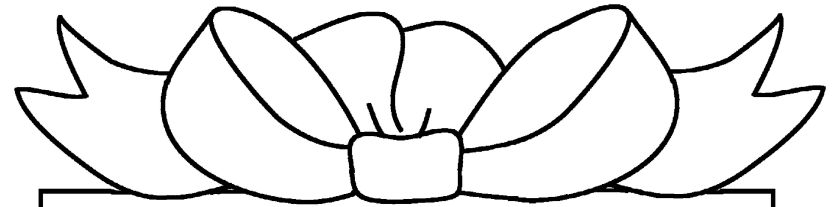

To: \_\_\_\_\_

From: \_\_\_\_\_

An angel of the Lord appeared to some shepherds who were keeping watch over their flocks by night.

What did the shepherds say to one another when the angel left them?

Help the shepherds find their way.  
Write down the letters along the correct path.

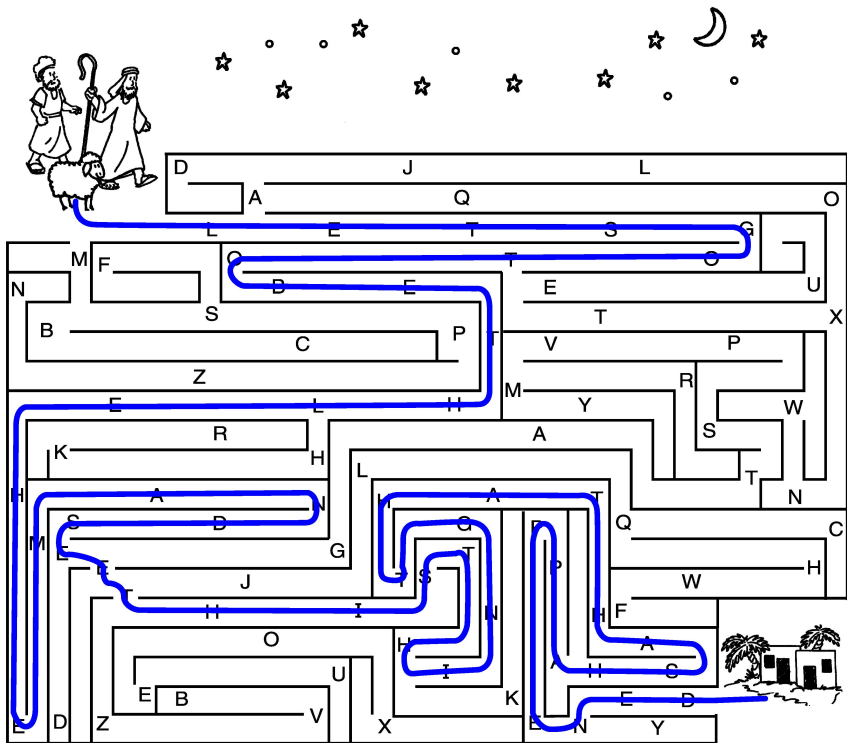

“Lets’ go to  
Bethlehem  
and see this  
thing that  
has happened.”

What happened next?

Use the code below to find out.

|       |       |       |       |       |
|-------|-------|-------|-------|-------|
| A = M | G = T | L = X | Q = G | V = I |
| B = W | H = C | M = V | R = E | W = R |
| C = F | I = U | N = H | S = Y | X = N |
| D = J | J = Q | O = D | T = B | Y = S |
| E = Z | K = A | P = L | U = P | Z = O |
| F = K |       |       |       |       |

They hurried  
off and found  
Mary and  
Joseph, and  
the Baby,  
who was  
lying  
in a  
manger.



Then what did the shepherds do?

Underline all the words containing an "e".  
Then find those words in the word search below.



When they had seen Him, they spread the word concerning what had been told them about this child, and all who heard it were amazed at what the shepherds said to them.

|   |   |   |   |   |   |   |   |   |   |   |   |   |
|---|---|---|---|---|---|---|---|---|---|---|---|---|
| C | F | E | A | D | M | E | H | T | H | G | B | C |
| L | O | I | M | J | I | W | P | E | N | A | K | M |
| T | P | N | F | E | Y | B | T | S | Y | T | O | H |
| I | D | T | C | H | J | K | A | E | N | C | E | E |
| B | M | C | L | E | E | F | H | R | I | G | L | A |
| S | A | N | H | I | R | T | L | E | D | J | E | R |
| V | O | E | M | D | M | N | F | A | C | S | H | D |
| G | W | E | R | E | L | E | I | J | K | D | I | O |
| I | E | W | P | Y | M | I | R | N | G | R | B | H |
| D | K | B | A | L | F | E | C | G | G | E | E | N |
| R | G | M | H | K | J | L | H | N | M | H | R | F |
| B | E | A | C | T | B | P | A | T | D | P | I | N |
| M | S | H | W | E | E | I | V | A | T | E | C | E |
| P | O | E | E | J | K | F | E | A | E | H | O | E |
| D | H | N | F | A | M | R | L | S | L | S | I | S |
| C | B | E | K | I | P | E | J | D | M | B | E | J |
| S | Y | M | F | S | H | F | D | E | Z | A | M | A |
| L | M | E | B | R | S | K | R | I | A | H | O | N |
| S | C | E | H | H | C | B | C | J | S | S | A | W |
| B | F | N | A | T | E | O | L | E | H | T | G | B |
| I | H | R | I | J | A | K | I | H | E | F | O | L |
| W | H | E | N | B | E | D | G | T | H | C | E | K |

# Merry Christmas!

Ages 7-12

Luke 2:15-21

*We Celebrate the Birth of Our Savior*

I hope you enjoy these Nativity activity pages.

An angel of the Lord appeared to some shepherds who were keeping watch over their flocks by night. What did the shepherds say to one another when the angel left them?

Help the shepherds find their way.  
Write down the letters along the correct path.

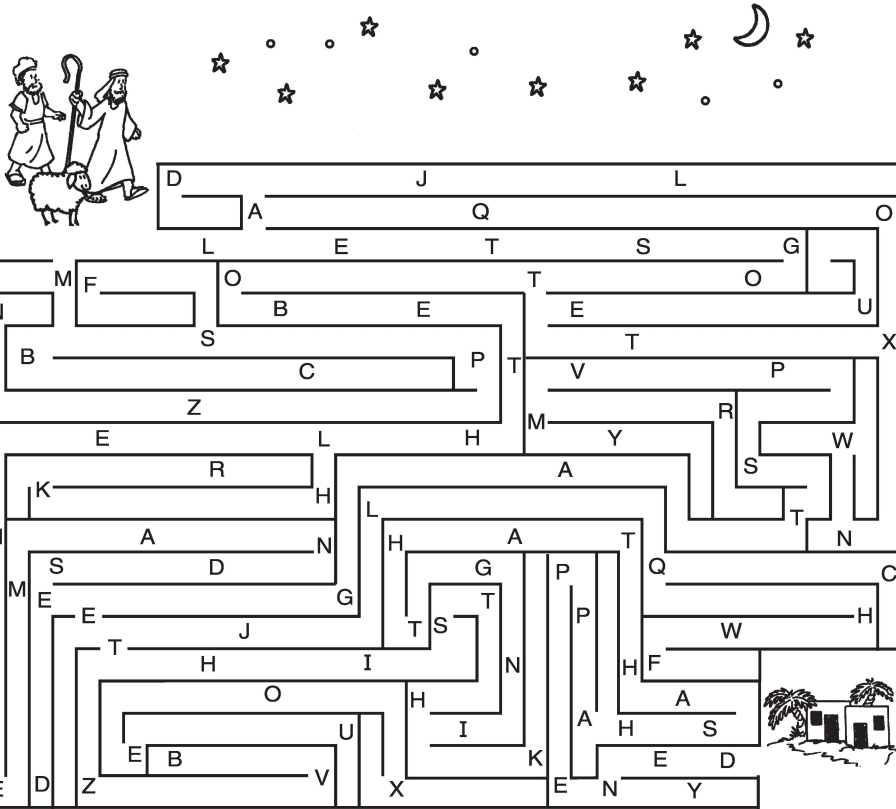

“ \_\_\_\_\_ ,  
\_\_\_\_\_  
\_\_\_\_\_  
\_\_\_\_\_  
\_\_\_\_\_ .”

What happened next?

Use the code below to find out.

|       |       |       |       |       |
|-------|-------|-------|-------|-------|
| A = M | G = T | L = X | Q = G | V = I |
| B = W | H = C | M = V | R = E | W = R |
| C = F | I = U | N = H | S = Y | X = N |
| D = J | J = Q | O = D | T = B | Y = S |
| E = Z | K = A | P = L | U = P | Z = O |
| F = K |       |       |       |       |

\_\_\_\_\_

G N R S N I W W V R O

\_\_\_\_\_

Z C C K X O C Z I X O

\_\_\_\_\_

A K W S K X O

\_\_\_\_\_

D Z Y R U N K X O

\_\_\_\_\_

G N R T K T S

\_\_\_\_\_

B N Z B K Y

\_\_\_\_\_

P S V X Q

\_\_\_\_\_

V X K

\_\_\_\_\_

A K X Q R W



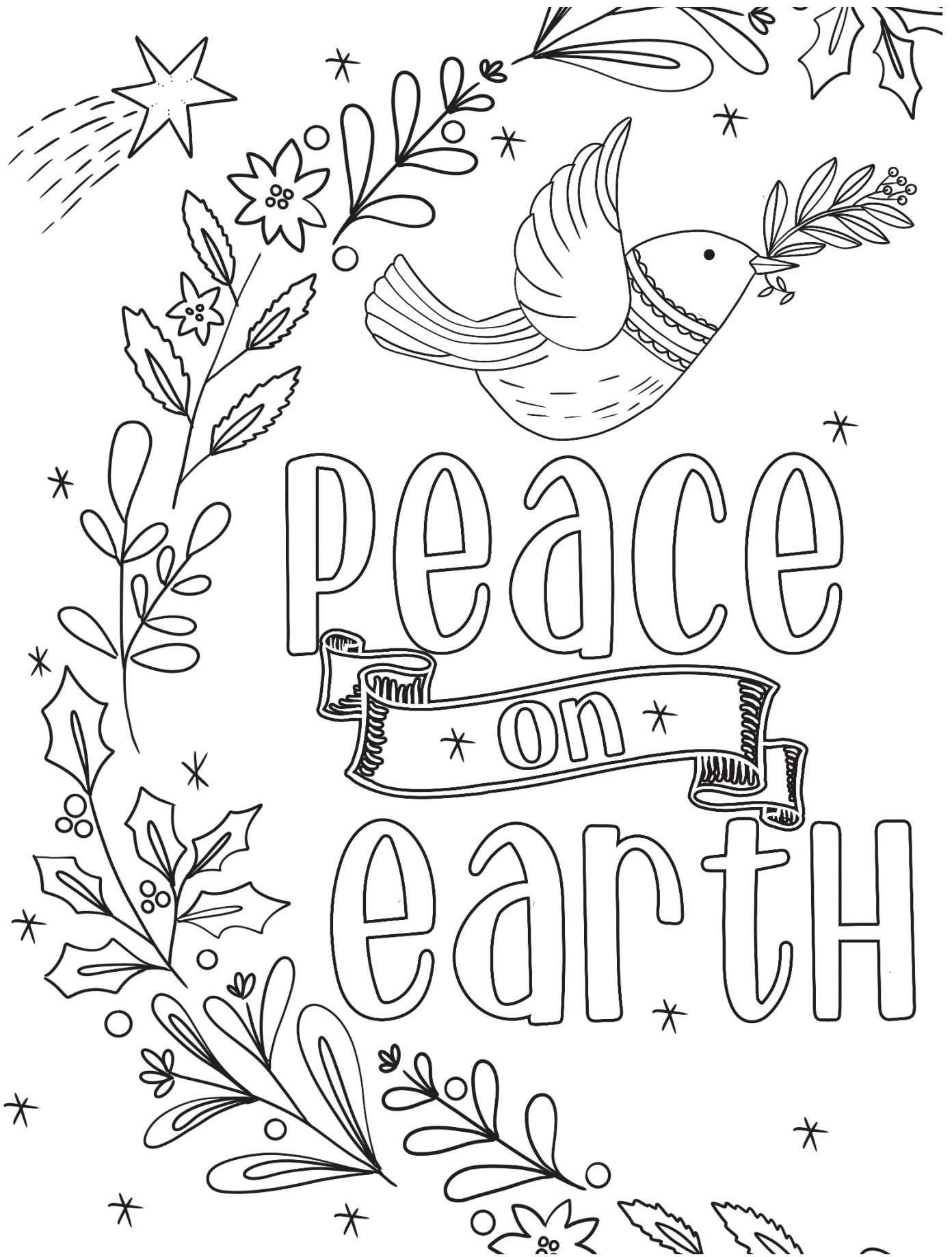

...his name  
shall be called



Wonderful  
Counselor,  
Mighty God,  
Everlasting  
Father,  
PRINCE  
of Peace



Isaiah 9:6



# Snowflake Star

Matthew 2:1-23

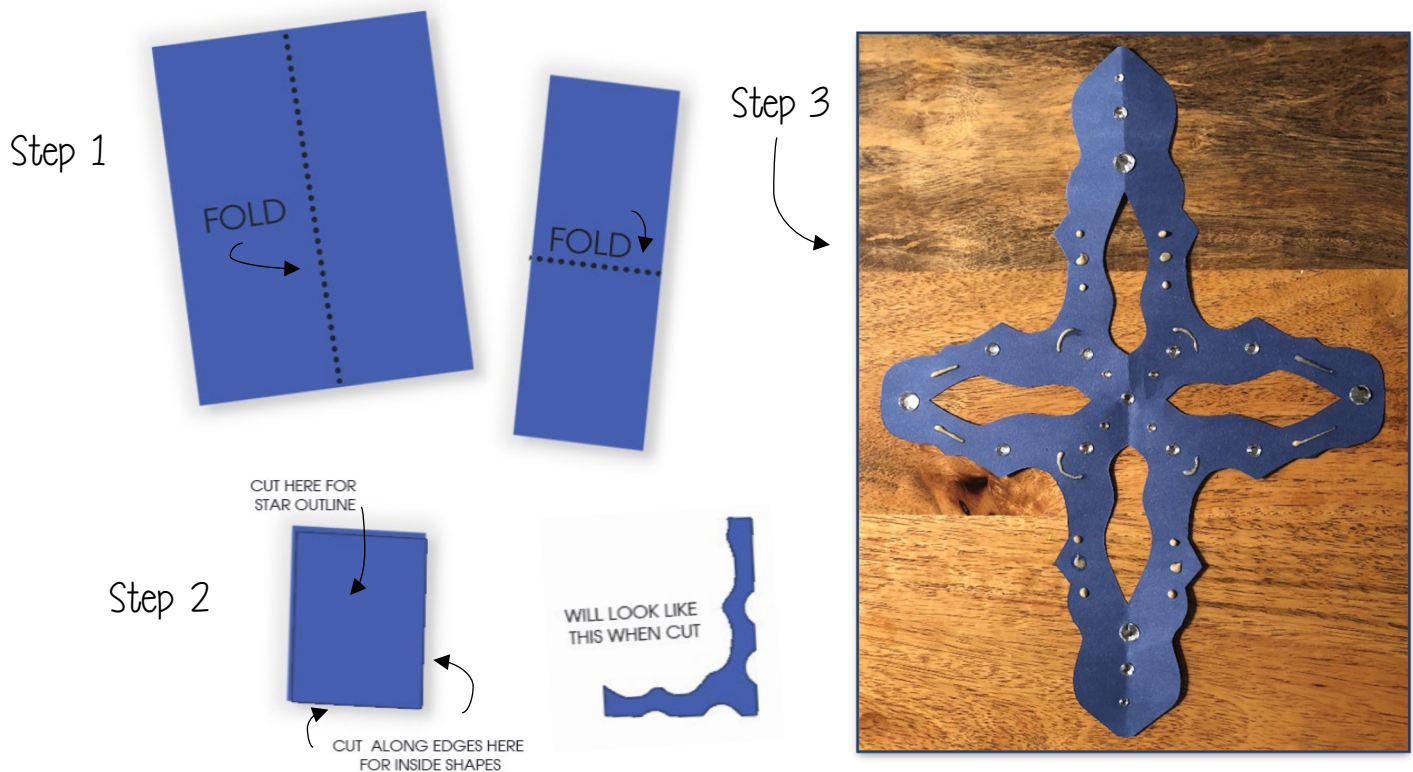

## Supplies you will need:

- Craft Jewels & Glitter
- Construction paper – any color!
- Scissors
- Glue
- Hole Punch
- Yarn or String

## Instructions:

1. Fold the paper in half the long way. Then fold again.
2. Cut out your “snowflake” star. Remember, do not cut all of the folds or it will not stay together.
3. Decorate your star!
4. Once dry, punch a hole in the top and tie a piece of string through the top to hang.

# Star Sewing Card

Matthew 2:1-23

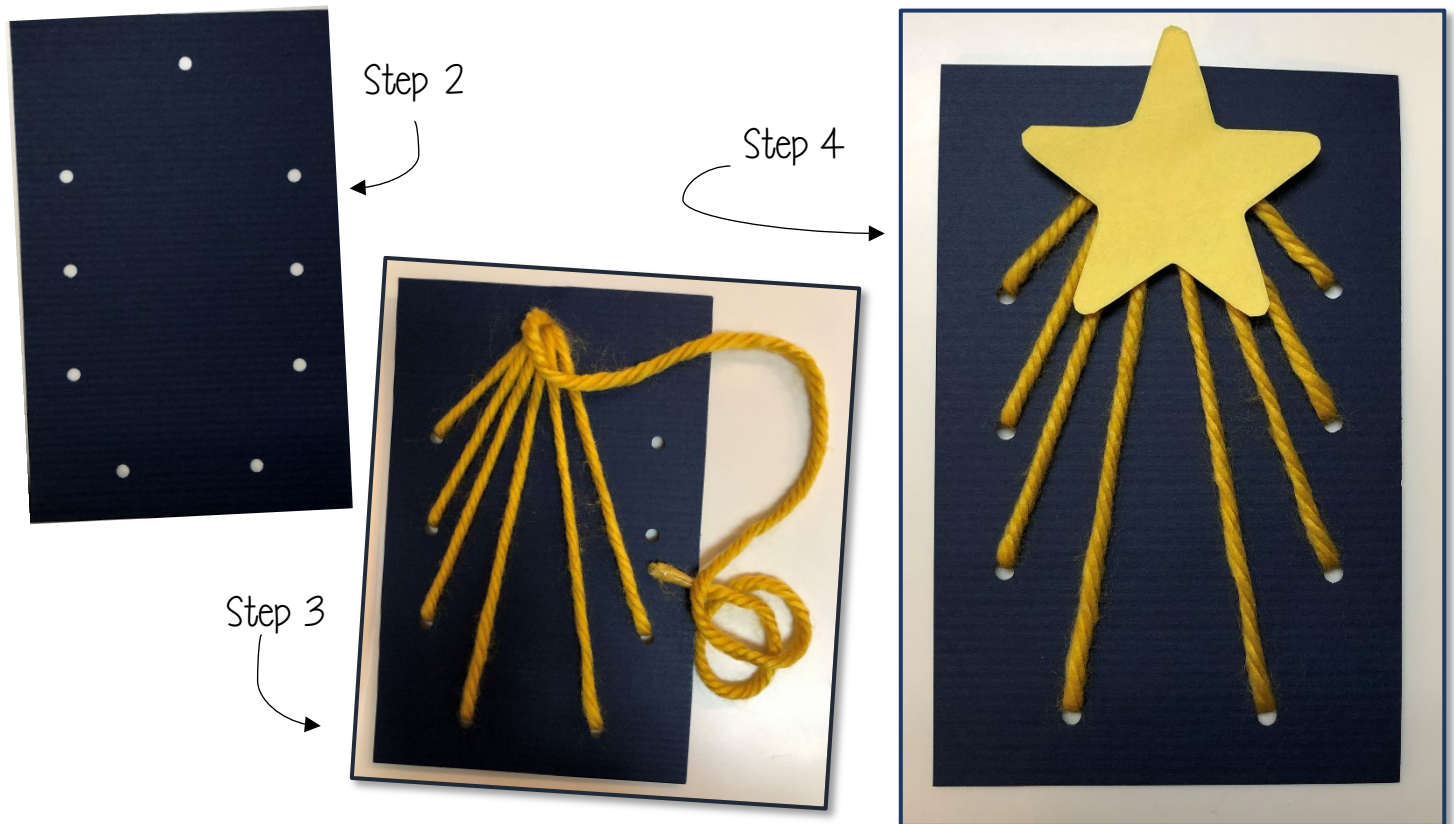

Supplies you will need:

- Yellow construction paper
- 3 yards of yellow yarn
- Blue cardstock or construction paper
- Tape
- Glue
- Hole punch
- Scissors
- Optional: Glitter or puffy paint

Instructions:

1. Cut a star shape out of yellow construction paper.
2. Cut a piece of 8.5" x 11" blue cardstock in half and punch holes as shown above.
3. Put yarn through the hole at the top and tape the end of the yarn to the back. Continue to sew the card, looping yarn back through the top hole each time.
4. Glue the paper star on top of the yarn. Optional: Add glitter to the star and blue paper.

# Star Template

Print or trace this star onto yellow paper for Step 1.

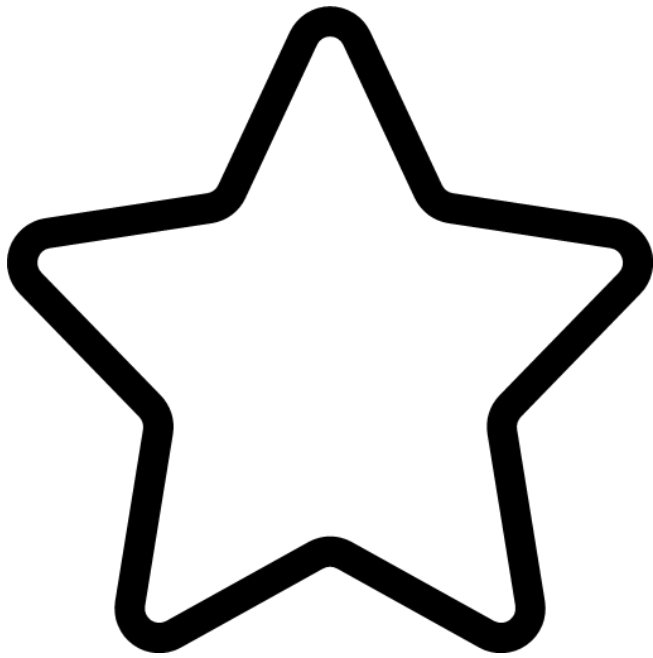

# Wreath Photo Craft

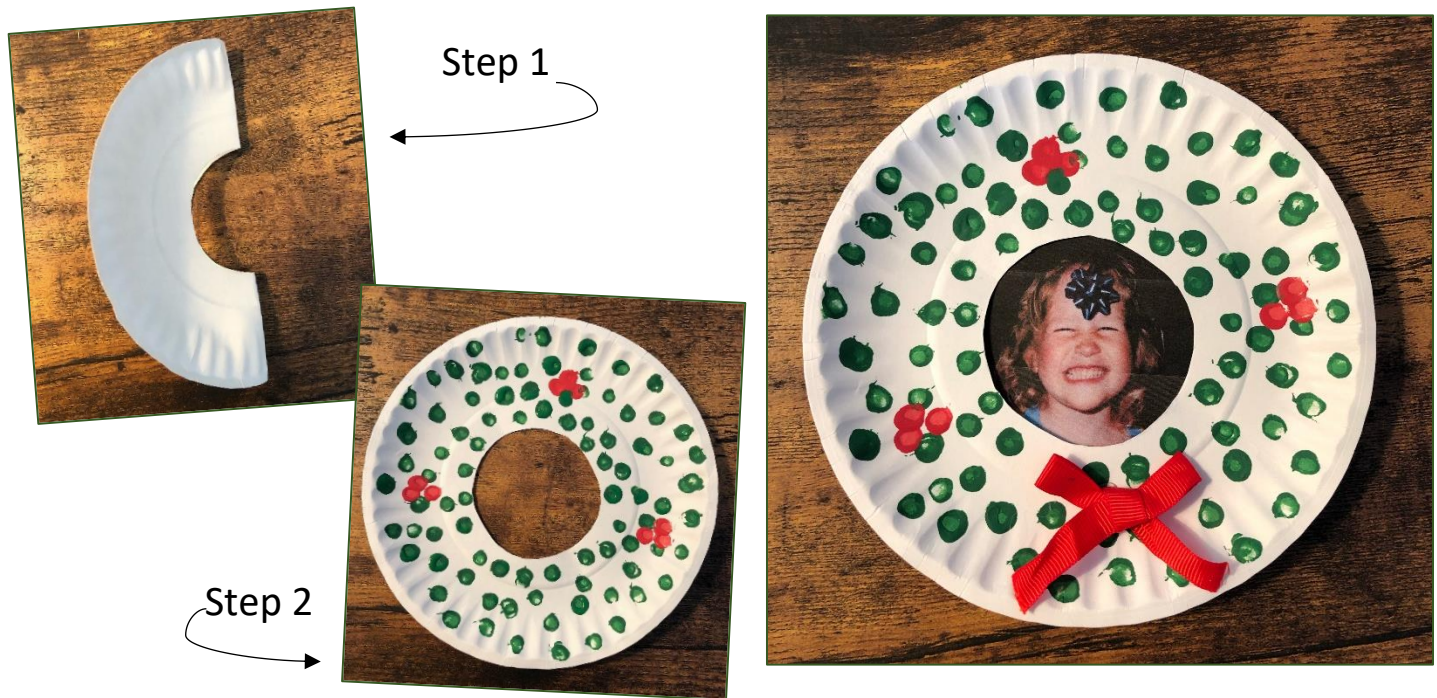

## Supplies you'll need:

- 6-inch paper plate (1 per child)
- Green paint
- Red paint
- Q-tips or paint brush
- Scissors
- Hot glue gun, craft glue or tape
- Photo
- Ribbon (optional)

## Instructions:

1. Fold the paper plate in half and cut a circle in the center.
2. Use the Q-tips or a paint brush to apply green paint to paper plate around the entire plate. Add red paint for berries.
3. Attach photo to back of plate so that the photo shows through the center hole cut.
4. Optional: Attach a bow to the front and/or string to the back to hang.

# The Christmas Story

• ACTIVITY PAGES • YOUNGER •

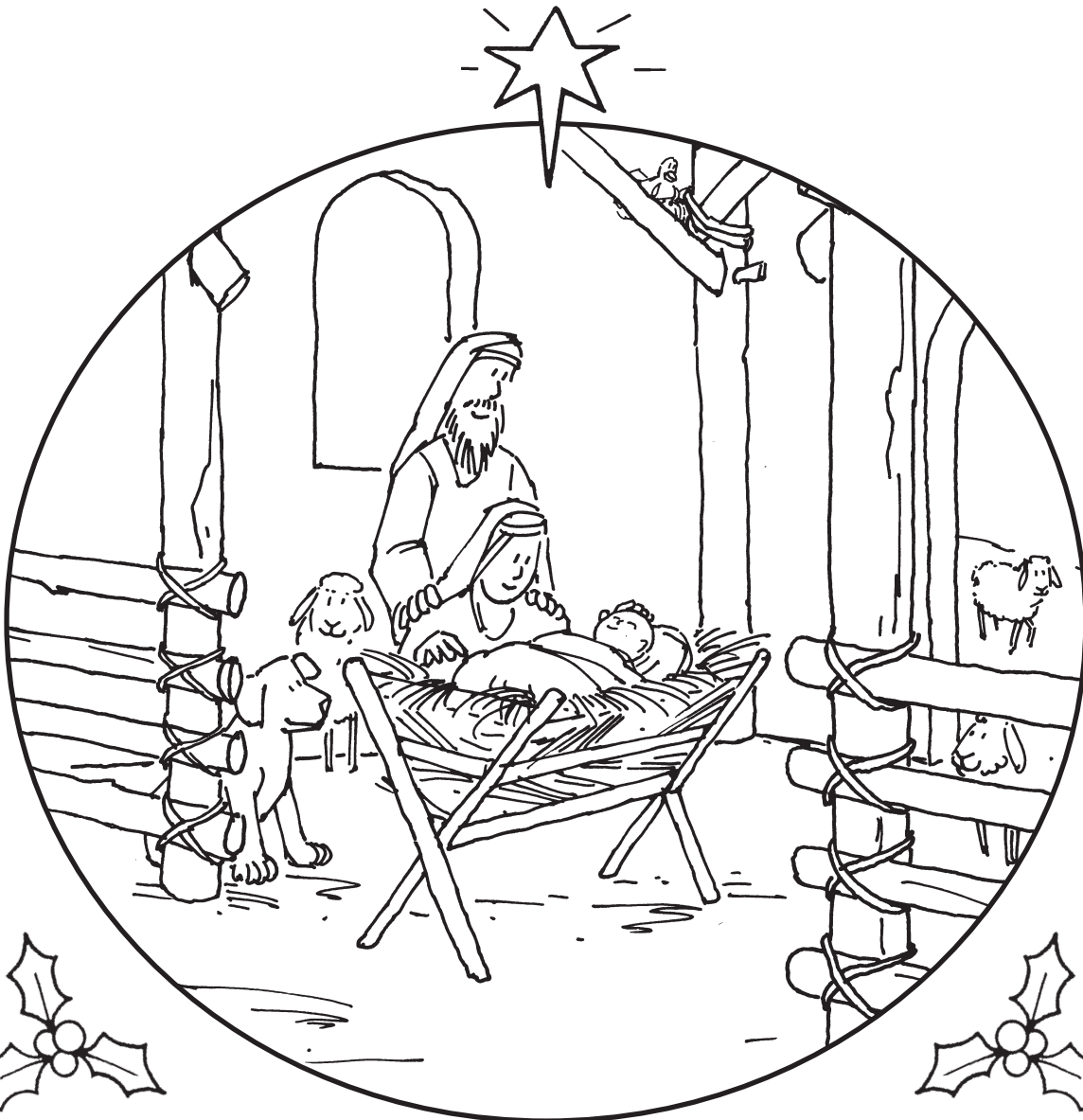

From your friends at *Children's Worship Bulletins*  
[www.ChildrensBulletins.com](http://www.ChildrensBulletins.com)

**M**ary and Joseph had to go to Bethlehem. There, Jesus was born in a stable.

Find 11 animals in the picture.

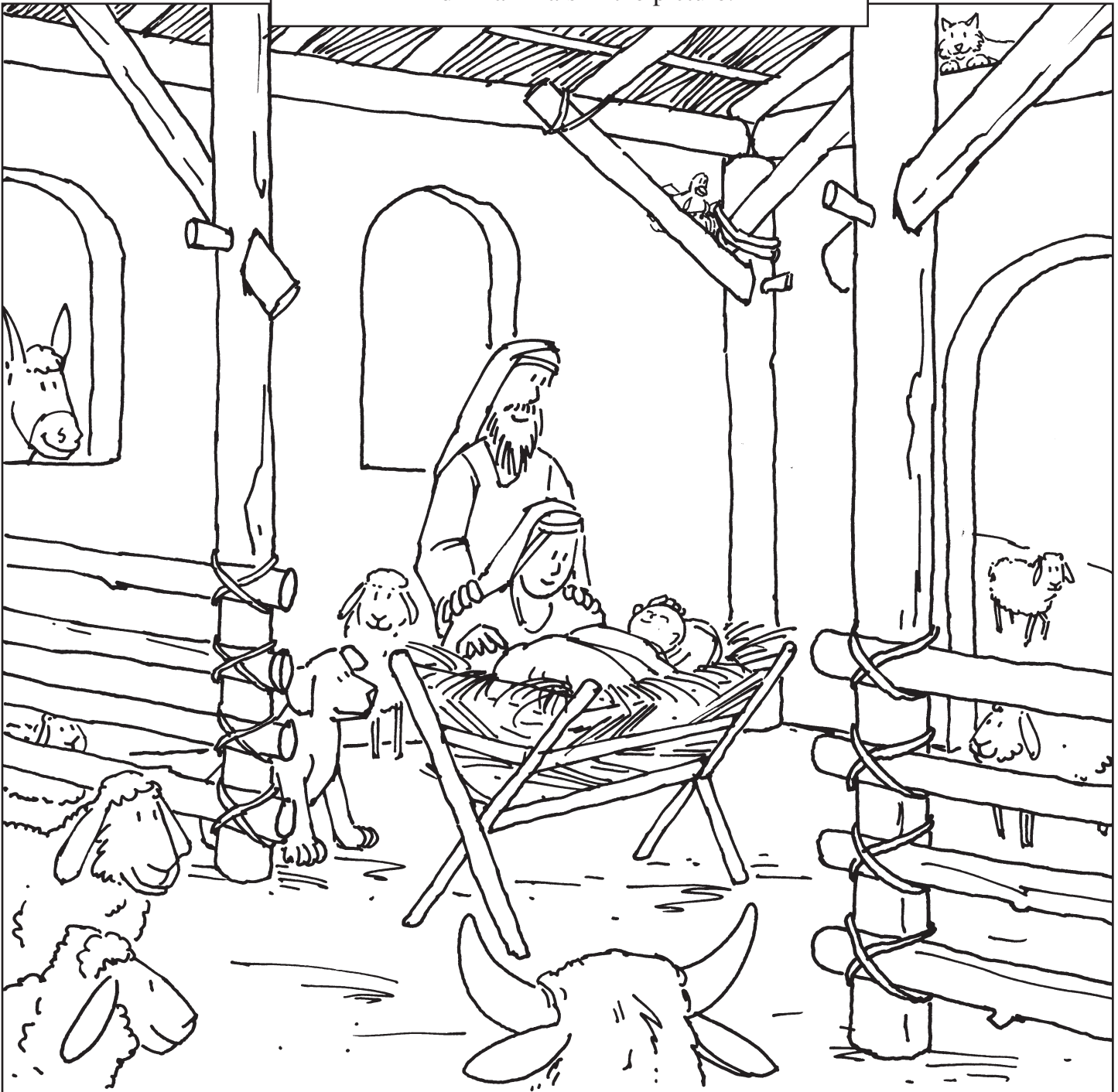

Name \_\_\_\_\_

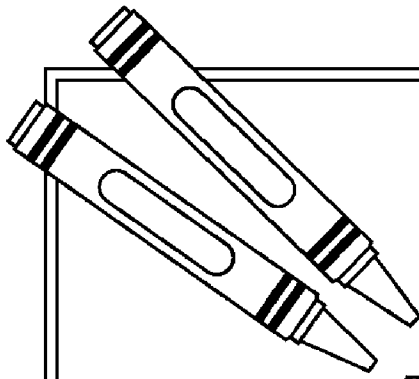

# Just for KIDS

## *The Shepherds and the Angel*

What did the angel of the Lord say to the shepherds?

*(Luke 2:11)*

Write the first letter of each picture on the lines.

“

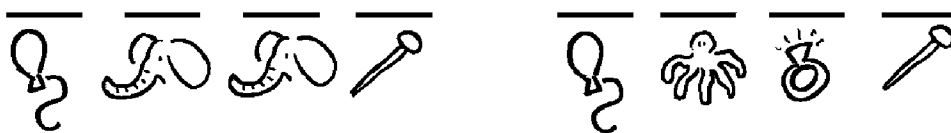

**T**he Magi followed a special star.  
 It led them to where Jesus was.

Shade in the shapes with .

 7 differences in the bottom picture.

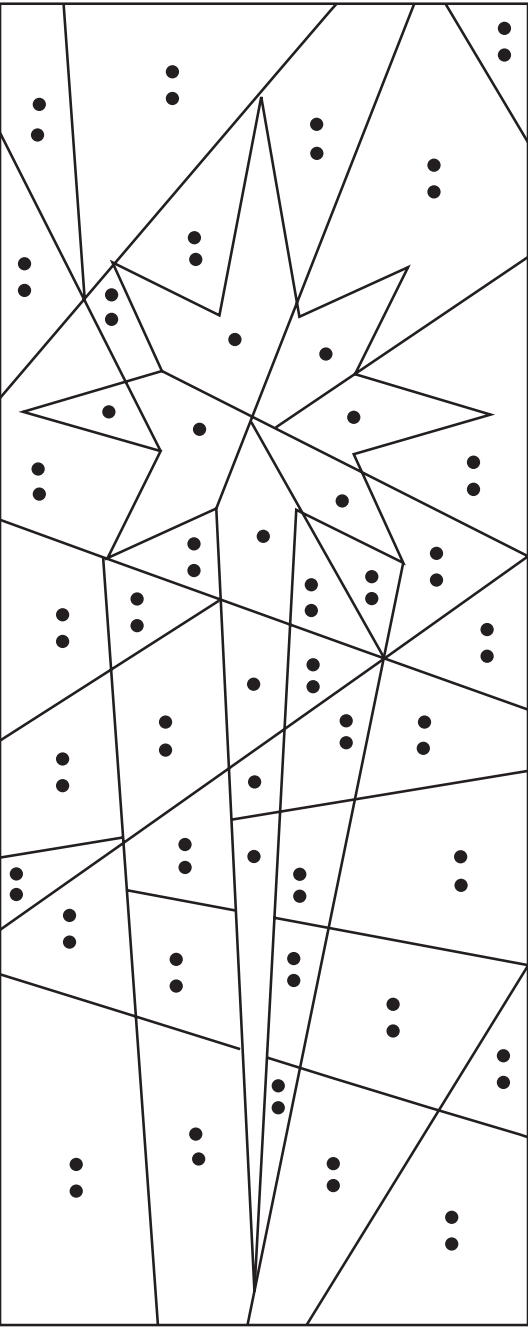

Jesus was in danger from King Herod so they escaped to Egypt. When it was safe, Joseph, Mary and Jesus came to live in Nazareth.

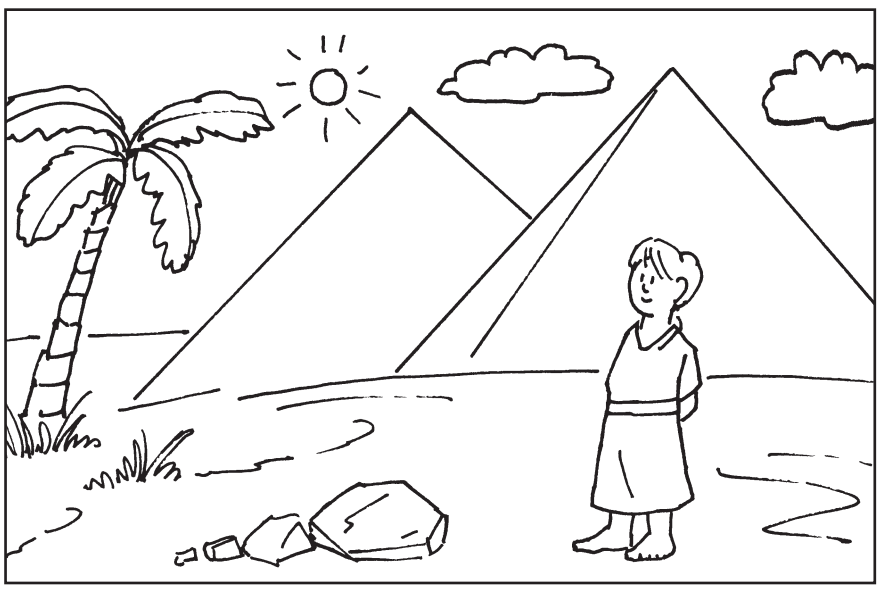

Name \_\_\_\_\_



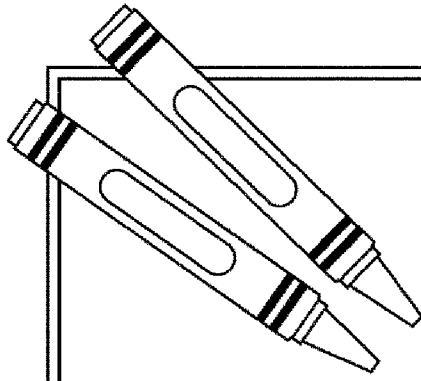

# Just for **KIDS**

## Christmas Riddles

Read the riddles below. Do you know the answers?

1. In a stable I was filled with hay  
And became a bed where a baby lay.

What am I? \_\_\_\_\_ (Luke 2:7)

2. Our voices loud were heard on high!  
The shepherds were frightened when we filled the sky!

Who are we? \_\_\_\_\_ (Luke 2:9-13)

3. I was shining in the Bethlehem sky that night.  
The three kings followed my light so bright!

What am I? \_\_\_\_\_ (Matthew 2:2)

4. We watched our sheep in the night so still;  
Then angels sang and woke up our hill!

Who are we? \_\_\_\_\_ (Luke 2:8)

5. I was at Mary's side for that special birth  
And raised the child as his "father on Earth."

Who am I? \_\_\_\_\_ (Luke 2:16)

6. "My heart in song to God I lift"  
said the young mother of God's special gift.

Who am I? \_\_\_\_\_ (Luke 2:19)

7. A baby boy, the Promised One!  
A gift from God, His beloved Son!

Who am I? \_\_\_\_\_ (Matthew 1:18)

8. The city of David, the little town,  
Where the Baby was born and the star shone down.

What am I? \_\_\_\_\_ (Luke 2:4)

9. From the East we traveled far.  
We found the child by the light of the star.

Who are we? \_\_\_\_\_ (Matthew 2:1)

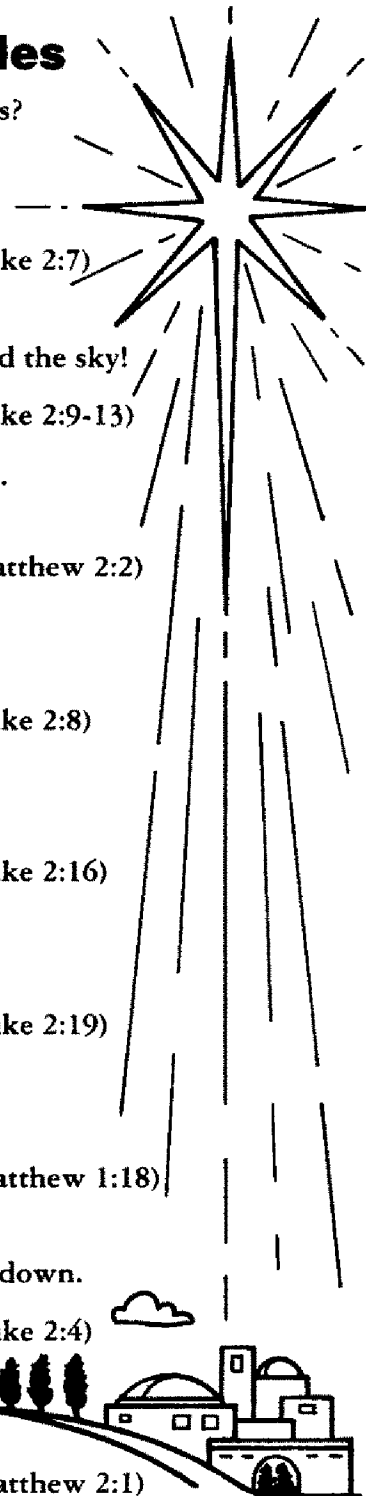

**S**imeon was in the temple. He believed God about the coming of Jesus. He was happy.

Connect the dots.

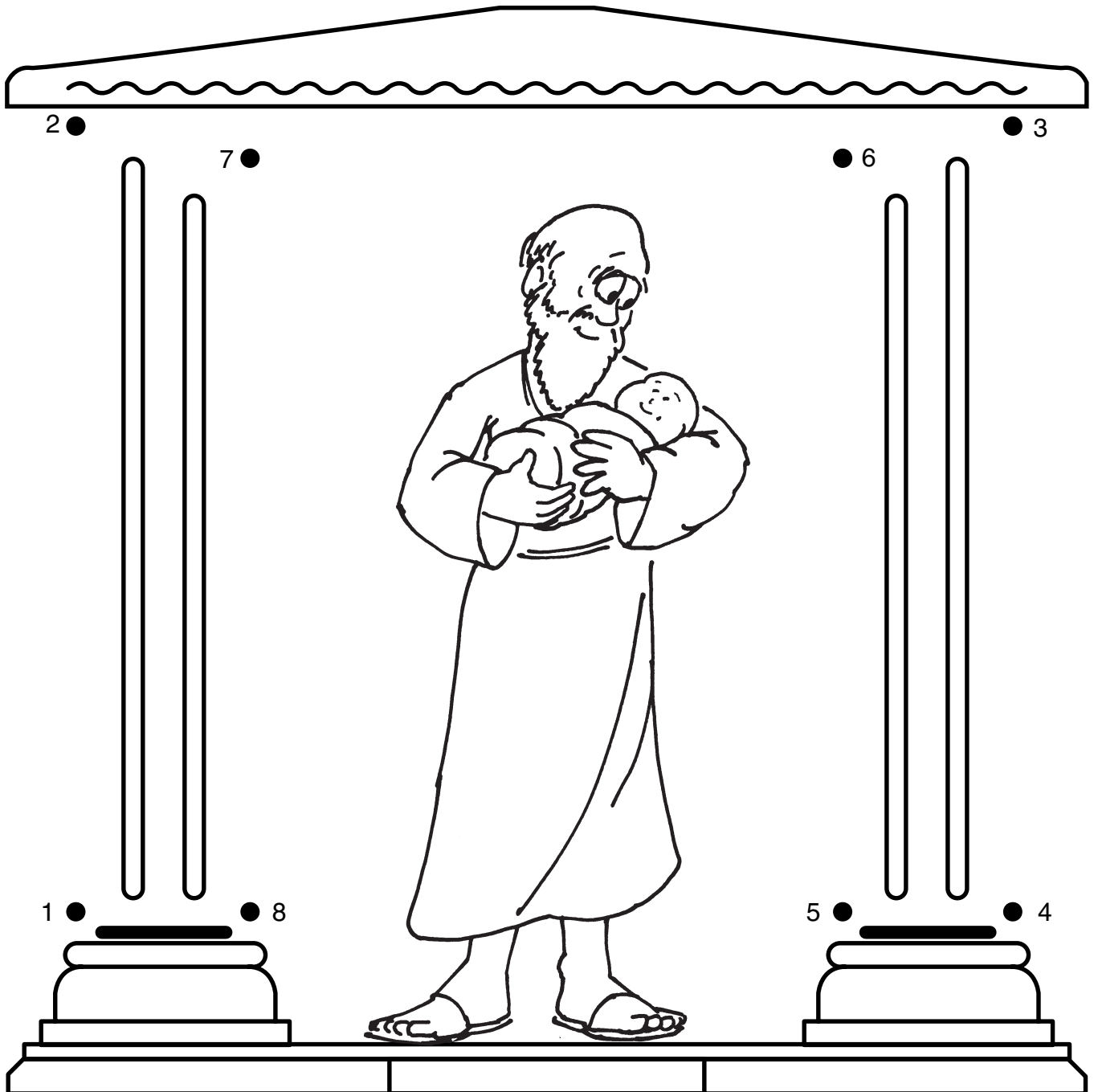

Name \_\_\_\_\_

The shepherds told everyone what they had seen, then went home, praising God.

Circle 7 differences in the 2nd picture.

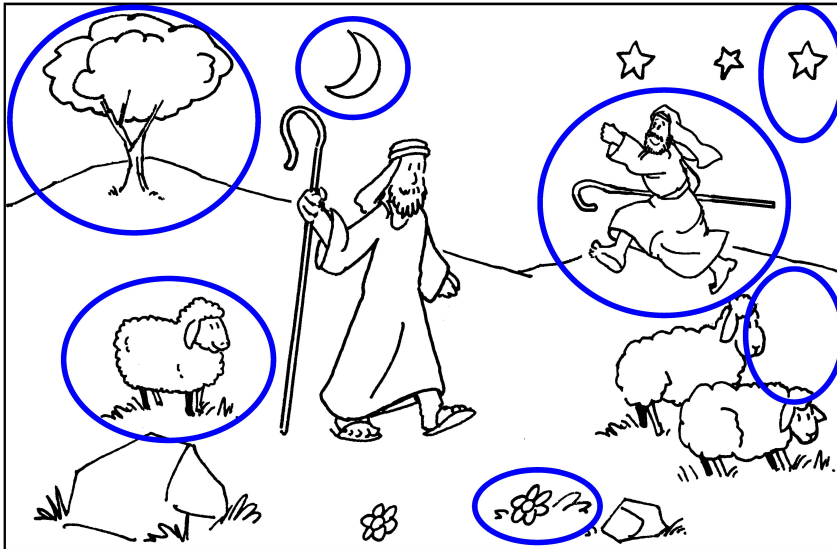

# Merry Christmas!

Ages 3-6

Luke 2:15-21

*We Celebrate the Birth of Our Savior*

I hope you enjoy these Nativity activity pages.

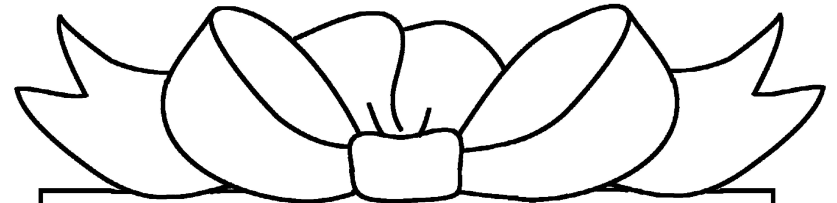

To:

\_\_\_\_\_

From:

\_\_\_\_\_

In the fields near Bethlehem, shepherds were caring for their sheep. An angel came and told them a Savior had been born. Immediately, the shepherds left to go see Jesus.

Help the shepherds get to baby Jesus.

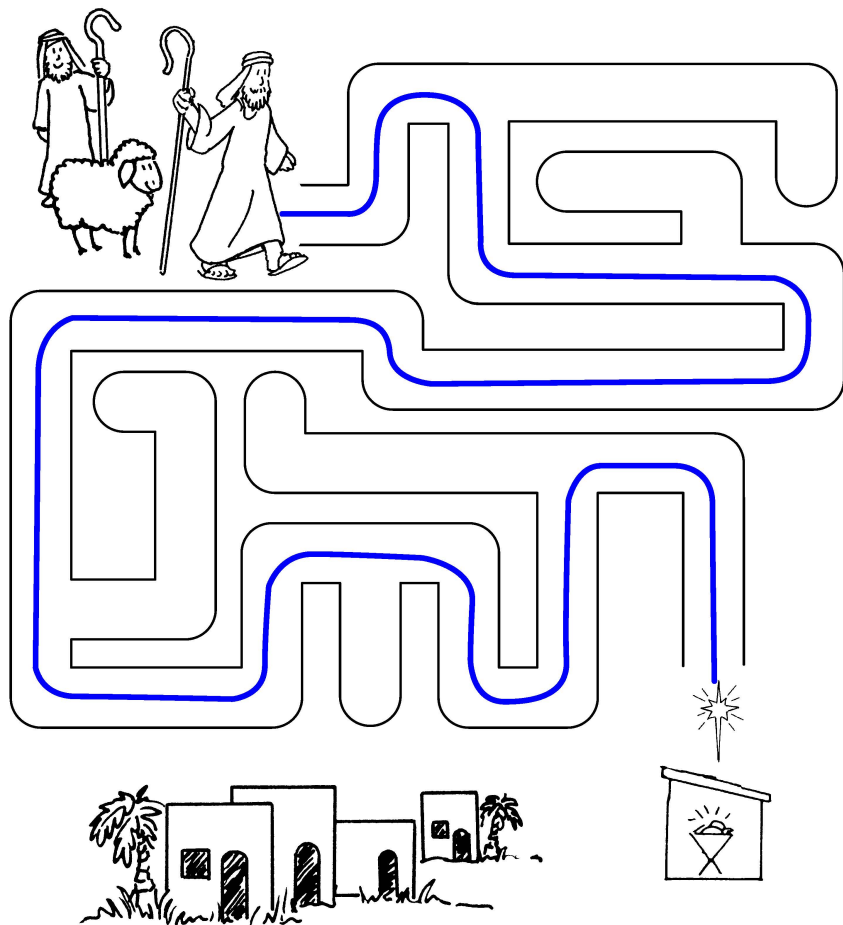

In a stable, they found Mary and Joseph, and the baby Jesus lying in a manger.

Connect the dots.  
1 2 3 4 5 6 7 8 9 10

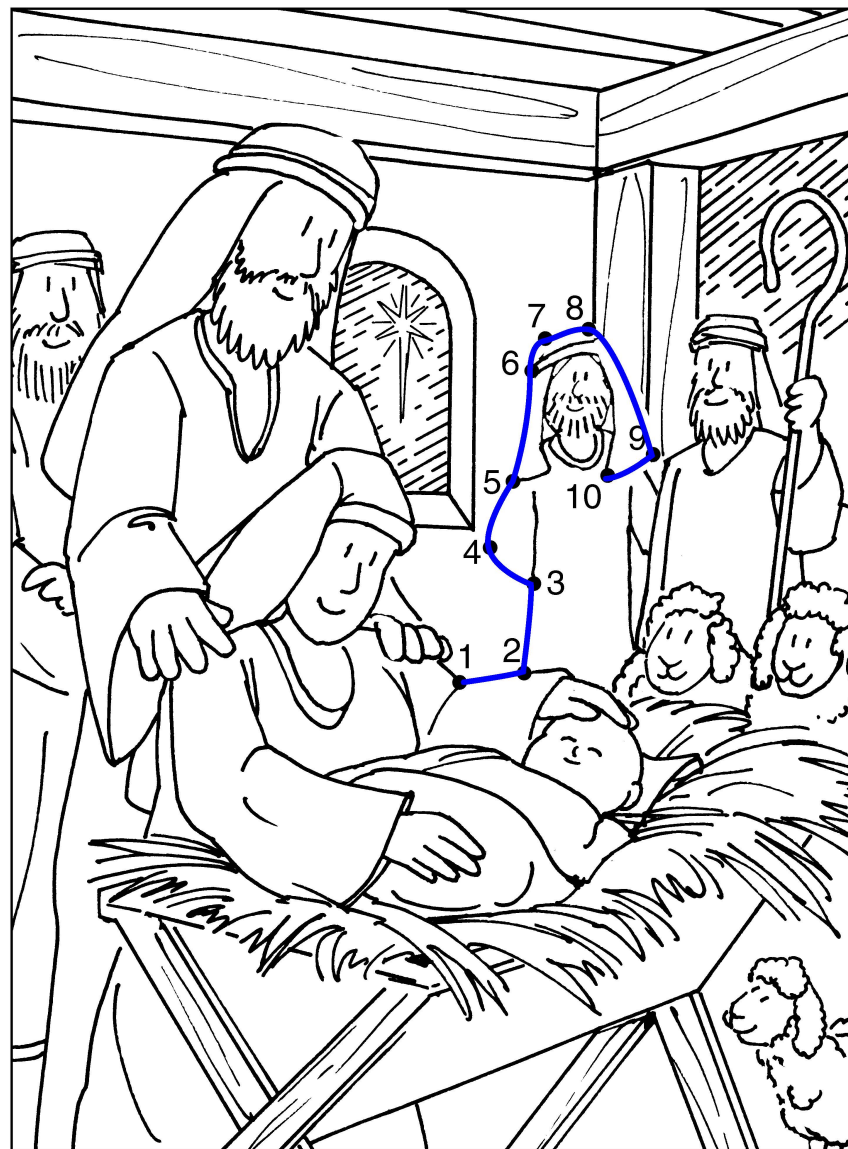

The shepherds told everyone what they had seen, then went home, praising God.

Circle 7 differences in the 2nd picture.



# Merry Christmas!

Ages 3-6

Luke 2:15-21

*We Celebrate the Birth of Our Savior*

I hope you enjoy these Nativity activity pages.

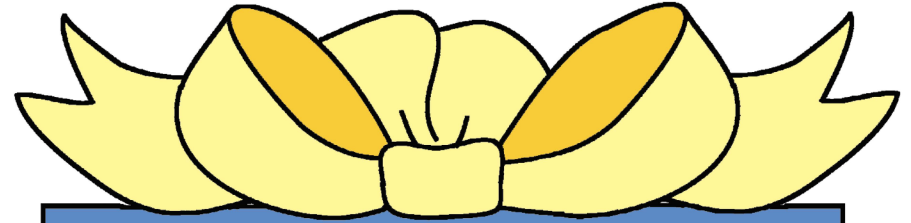

To:

\_\_\_\_\_

From:

\_\_\_\_\_

In the fields near Bethlehem, shepherds were caring for their sheep. An angel came and told them a Savior had been born. Immediately, the shepherds left to go see Jesus.

Help the shepherds get to baby Jesus.

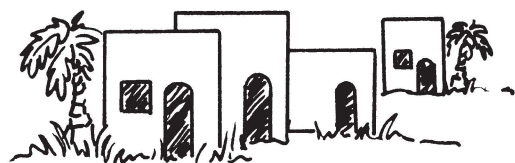
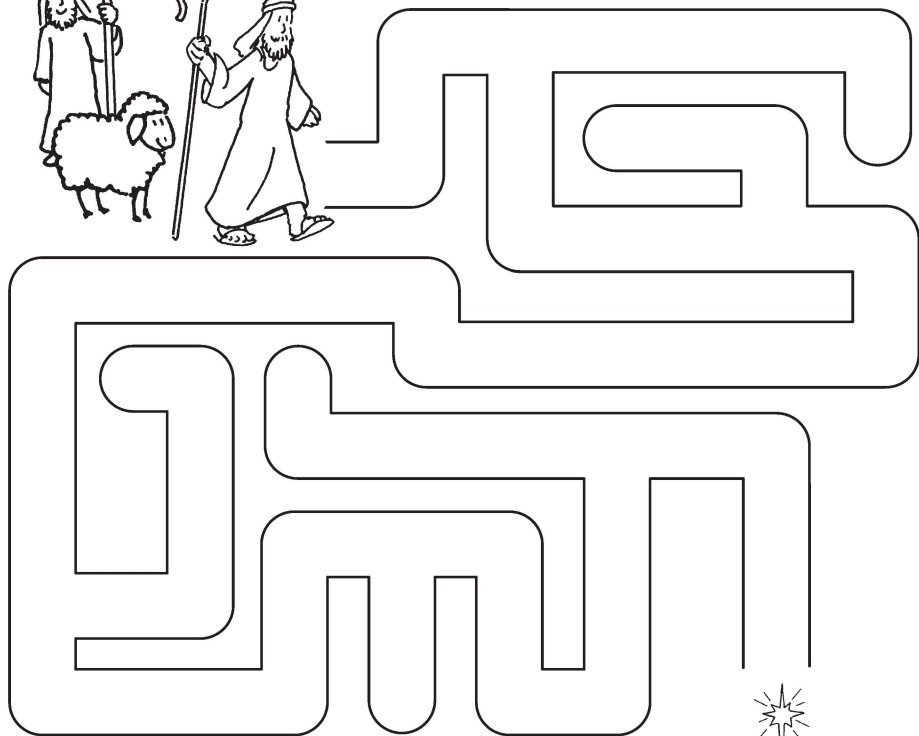

In a stable, they found Mary and Joseph, and the baby Jesus lying in a manger.

Connect the dots.  
1 2 3 4 5 6 7 8 9 10

