



Clap



Twist



Jumping Jacks



Jump

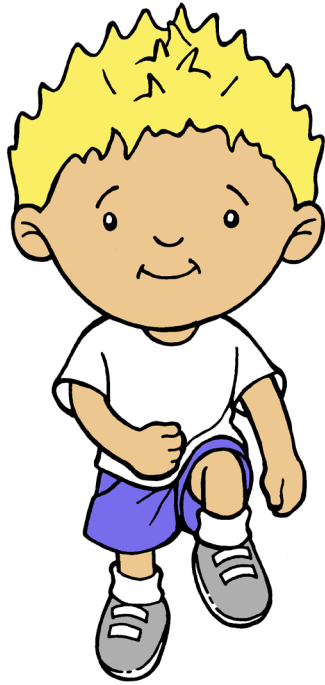

March



Pat Head



Spin

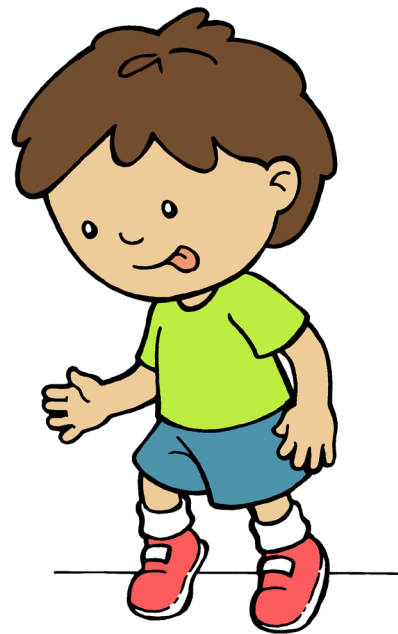

Tip Toe



Clap



Twist



Jumping Jacks

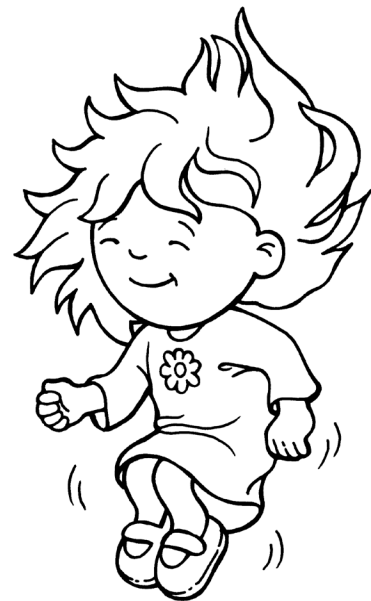

Jump



March



Pat Head



Spin

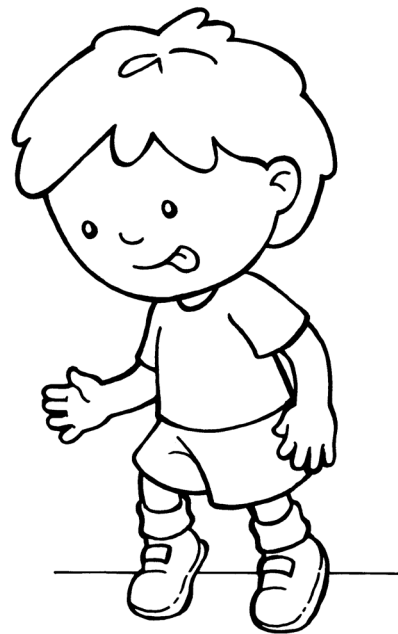

Tip Toe

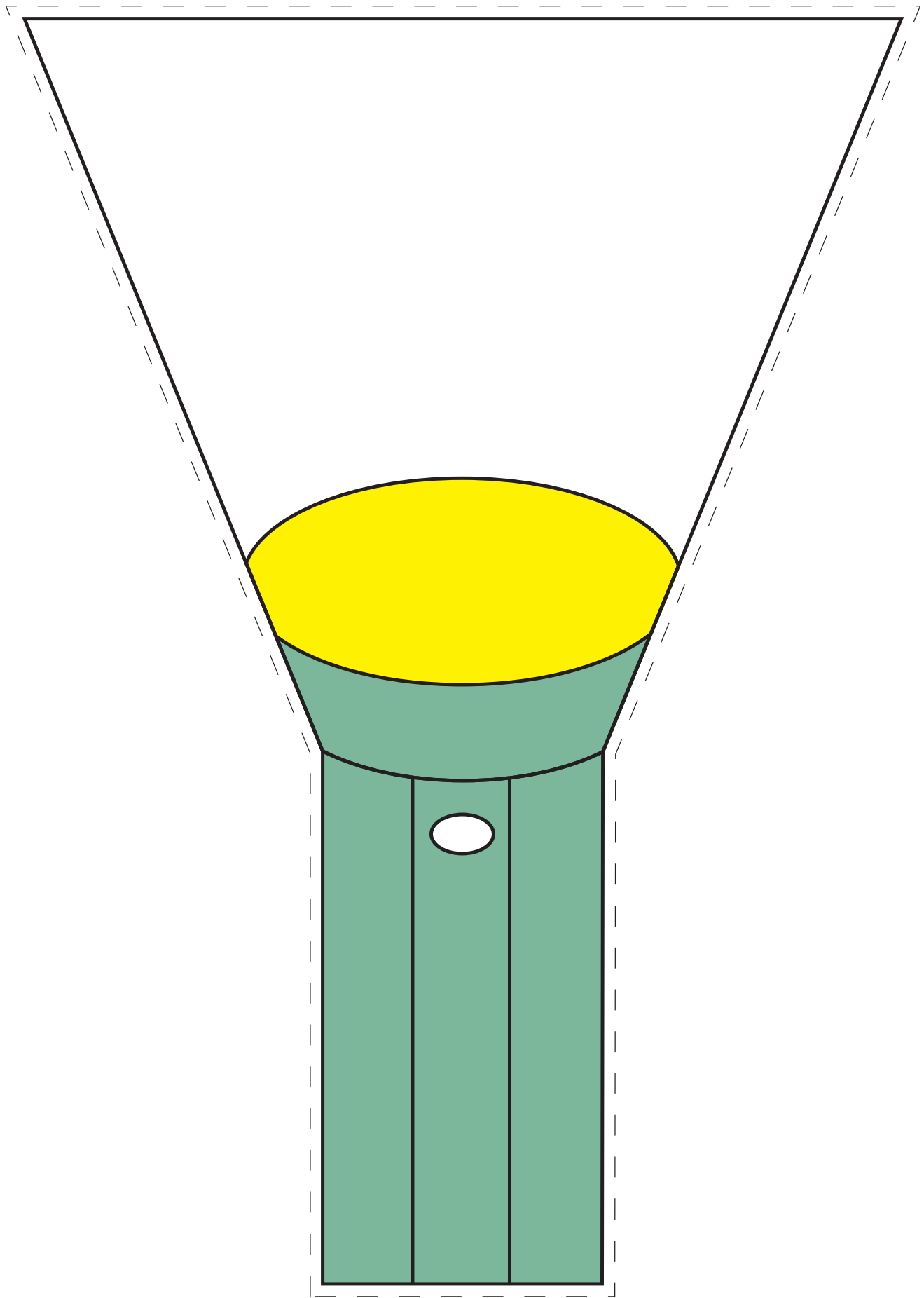

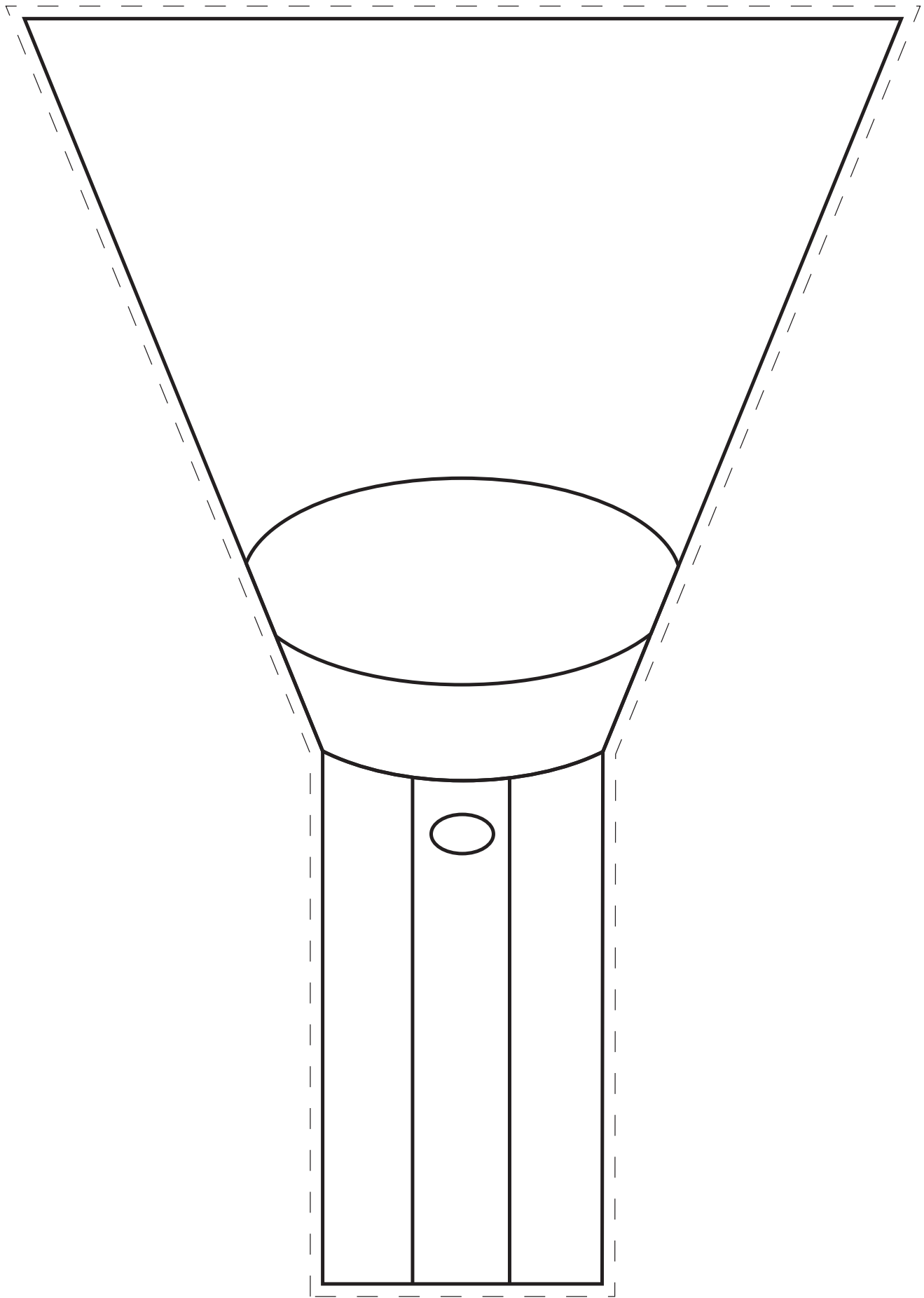

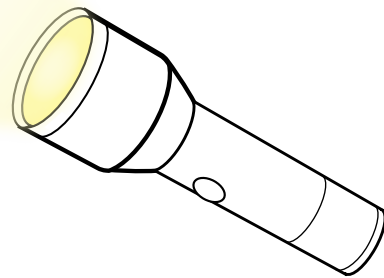
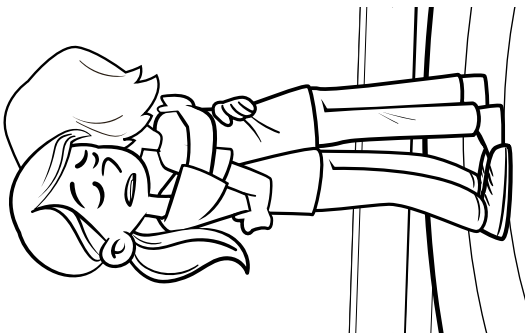
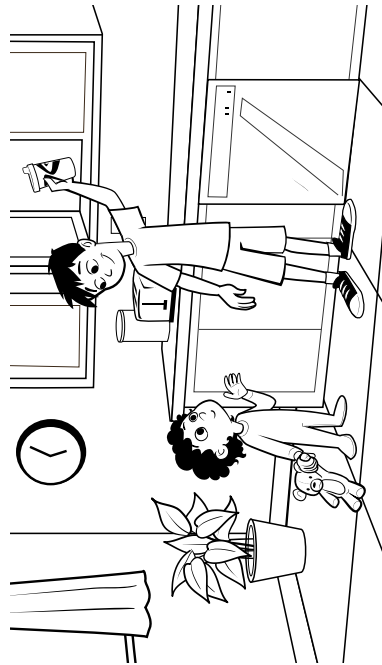
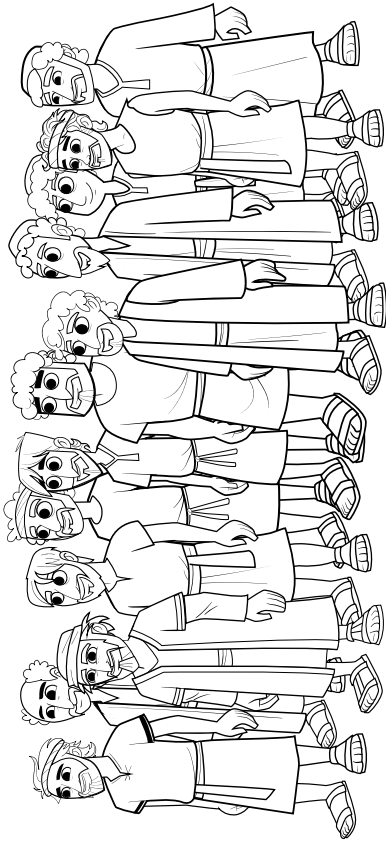
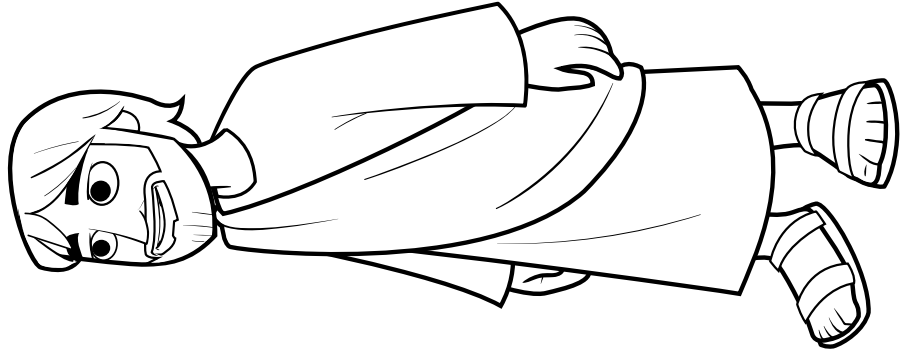
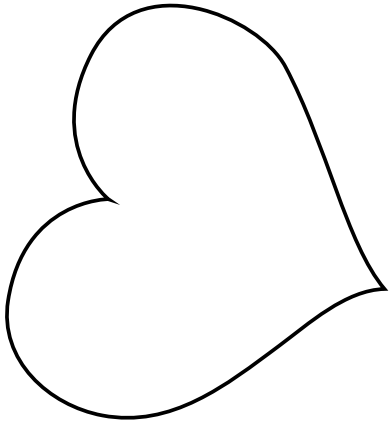

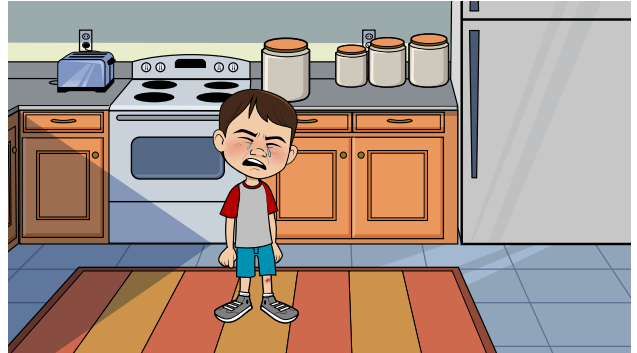
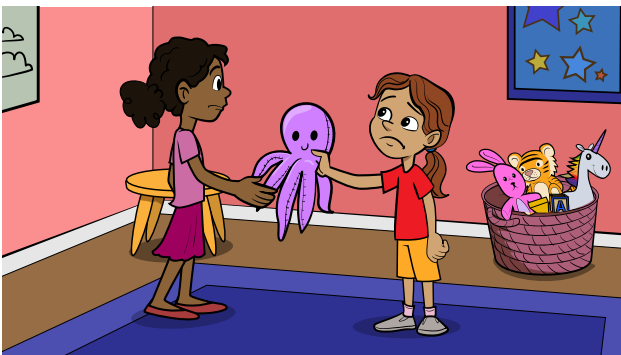
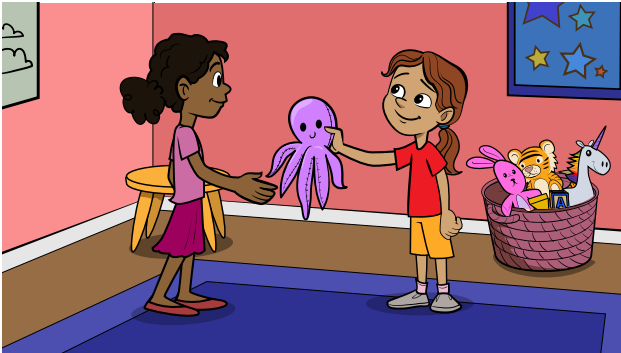
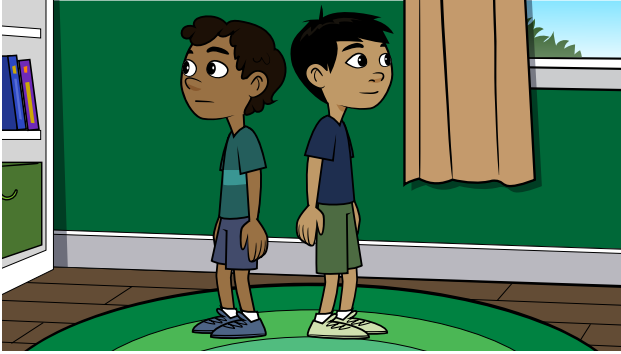

I can do what Jesus says.

Light of the World • Matthew 5:1-2, 14-16

Let Your Light Shine • Color • *Let Your Light Shine* • April Week 1
Copy on cardstock. One per child.

CURRICULUM FOR 3-5-YEAR-OLDS • ©2024 The reThink Group. All rights reserved. • www.ThinkOrange.com

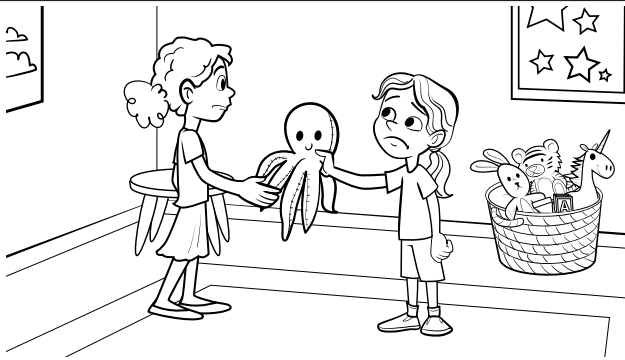
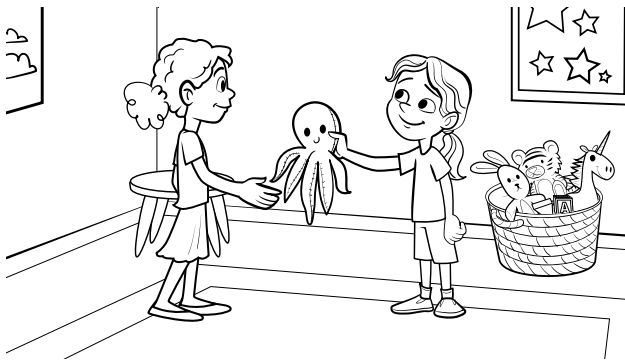
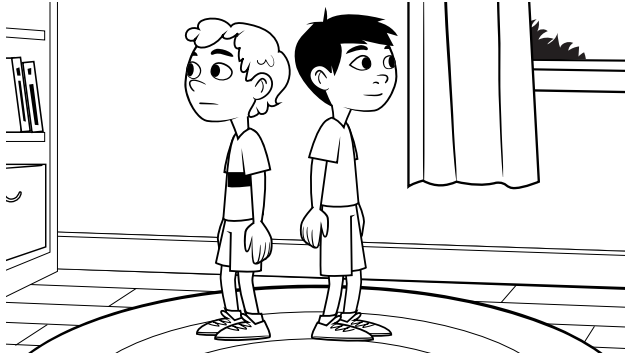

I can do what Jesus says.

Light of the World • Matthew 5:1-2, 14-16

Let Your Light Shine • B&W • *Let Your Light Shine* • April Week 1
Copy on cardstock. One per child.

CURRICULUM FOR 3-5-YEAR-OLDS • ©2024 The reThink Group. All rights reserved. • www.ThinkOrange.com